

Metal Bellows Coupling

with split hubs

optional
laserwelded
optional full stainless
steel version

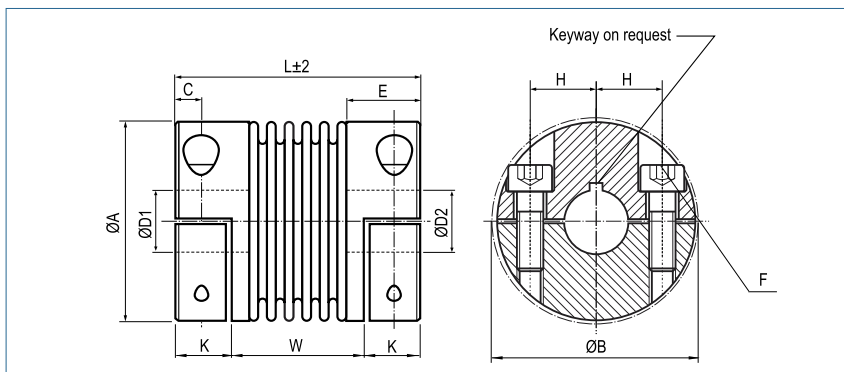

Order Code

KB4H / 60 - 83 - 20 - 20 - (S)

Type / Size

Length
L

ØD1
(H7)

ØD2
(H7)

Options

Size	Torque TKN (Nm)	Dimensions (mm)										Technical Data								
		L Length (±2)	Ø A Outer Ø	D1/D2 Bore Sizes (H7) min-max	H	C	E	W	K	B	F Screw (ISO4762) TA (Nm)	Mass (kg)	Moment of Inertia J	Spring Stiffness			Misalignment			max. speed (min-1)
														torsional CT 10 ³ (Nm/rad)	radial CR (N/mm)	axial CA (N/mm)	radial ΔKr (mm)	axial ΔKa (mm)	angular ΔKw (°)	
18	18	63	45	10-25.4	17	5.5	19.5	37	13	47.4	M5	0.1	0.04	20	205	50	0.2	0.5	1.5	12800
		71						45												
30	30	69	56	10-32	20	7.5	27	35	17	56.4	M6	0.3	0.14	38	720	50	0.15	0.6	1.5	10300
		77		43				15												
60	60	83	66	12-35	23	9.5	31	41	21	66.2	M8	0.5	0.28	75	1150	90	0.15	0.6	1.5	8700
		93						51												
80	80	94	82	12-44	28	11	36	47	23.5	82.9	M10	0.9	0.65	128	1200	80	0.2	0.5	1.5	6900
		106						59												
150	150	95	82	14-44	28	11	36	48	23.5	82.9	M10	0.9	0.82	155	2020	145	0.2	0.5	1.5	6900
		107						60												
200	200	105	90	16-47	31	12.5	41	51	27	90.8	M12	1.3	2.2	175	2500	145	0.2	0.5	1.5	6400
		117						63												
300	300	111	110	20-60	39	13	41	55	28	110	M12	1.8	4.2	502	6300	280	0.2	0.5	1.5	6000
		125						69												
500	500	133	122	25-70	42	15	51	62	35.5	122	M12	2.50	8.6	690	7790	100	0.2	0.5	1.5	5000
		146						75												
800	800	168	157	40-80	55	22.5	66.5	77	45.5	168	M20 400	14.8	57.65	1270	700	275	0.2	0.8	1.8	5000
1400	1400	168	157	50-80	55	22.5	66.5	77	45.5	168	M20 400	15.3	58.70	1270	700	275	0.2	0.8	1.8	5000

Material	bellows - stainless steel hub - to size 500: aluminium hub - from size 800: steel
Hub	bore tolerance: H7
Temperature Range	-30 °C ~ 120 °C size 800/1400: -30 °C ~ 250 °C
Keyway	optional acc. DIN 6885 biggest bore marked with a #